



# AT-AM2-1850-15XC2

Active Multiplier x2, 18-50GHz Pout=+15dBm

## Active X2, 18-50GHz Frequency Doubler

2022-7-1



### Description:

AT-AM2-1850-15XC2 is a broadband frequency doubler. The doubler has an input frequency of 9-25 GHz with a typical output +15dBm from 18-50GHz.

The integrated output buffers deliver high output power at a low drive level. The doubler also has a typical harmonic suppression. The input port is SMA female, and the output is 2.4mm Male in default and 2.4mm Male is available according to request..

More information, please visit [www.atmicrowave.com](http://www.atmicrowave.com)

### Feature

- ✓ Frequency: 18-50GHz
- ✓ Pout: +15dBm typical
- ✓ Input: 9-25GHz
- ✓ Low Harmonics

### Application

- ✓ 5G Communication
- ✓ Test Equipment
- ✓ ROF (RF Over Fiber)
- ✓ Radar System

### Electronical Specifications:

Parameter	Min	Typical	Max
Input Frequency		9-25GHz	
Input Power	+10	+13dBm	+15
Multiplier Factor		X2	
Output Frequency		18-50GHz	
Output Power	+13dBm +12dBm	18-48GHz: +15dBm 48-50GHz: +13dBm	
1 <sup>st</sup> Harmonic Suppression	-20dBc	-30dBc	
3 <sup>rd</sup> Harmonic Suppression	-20dBc	-30dBc	
Drain Voltage		+5V	+8V
Current		250mA	
Spec Temp		+25C	





# AT-AM2-1850-15XC2

Active Multiplier x2, 18-50Hz Pout=+15dBm

## Mechanical Information

Item	Description
Input Port	SMA Female
Output Port	2.4mm Male
Case Material	Copper
Finish	Gold Plated
Weight (Without Heatsink)	80g
Size:	30x30x14mm

## Absolute Maximum Ratings Table

Parameter	Value
Drain Supply	+13V
RF Input Power	+23dBm
Operating Temperature	-40 to +85C
Storage Temperature	-55 to +125C

### Notes:

- ✓ Datasheet may be changed according to update of MMIC, Raw materials , process, and so on.
- ✓ This data is only for reference, not for guaranteed specifications.
- ✓ Please contact AT Microwave team to make sure you have the most current data.
- ✓ Always pay attention to the temperature of the case, heatsink and fan are required if case temperature exceeds over 50C.

## Part Number Selection Guide

Item	Description
PN	Stand Module with DC Power Supply
<b>PN-LCBT</b>	<b>L</b> ow Cost, <b>C</b> ompact <b>B</b> ench- <b>T</b> op, +220V Supply with AC/DC Adapter

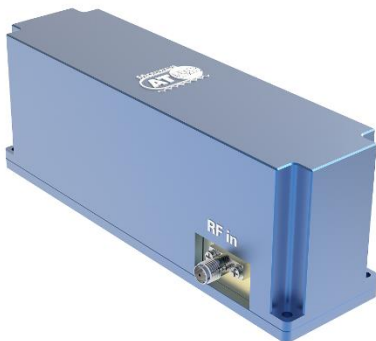



# AT-AM2-1850-15XC2

Active Multiplier x2, 18-50Hz Pout=+15dBm

## Test Data (25C)

Please note that test curves will vary slightly from unit to unit.

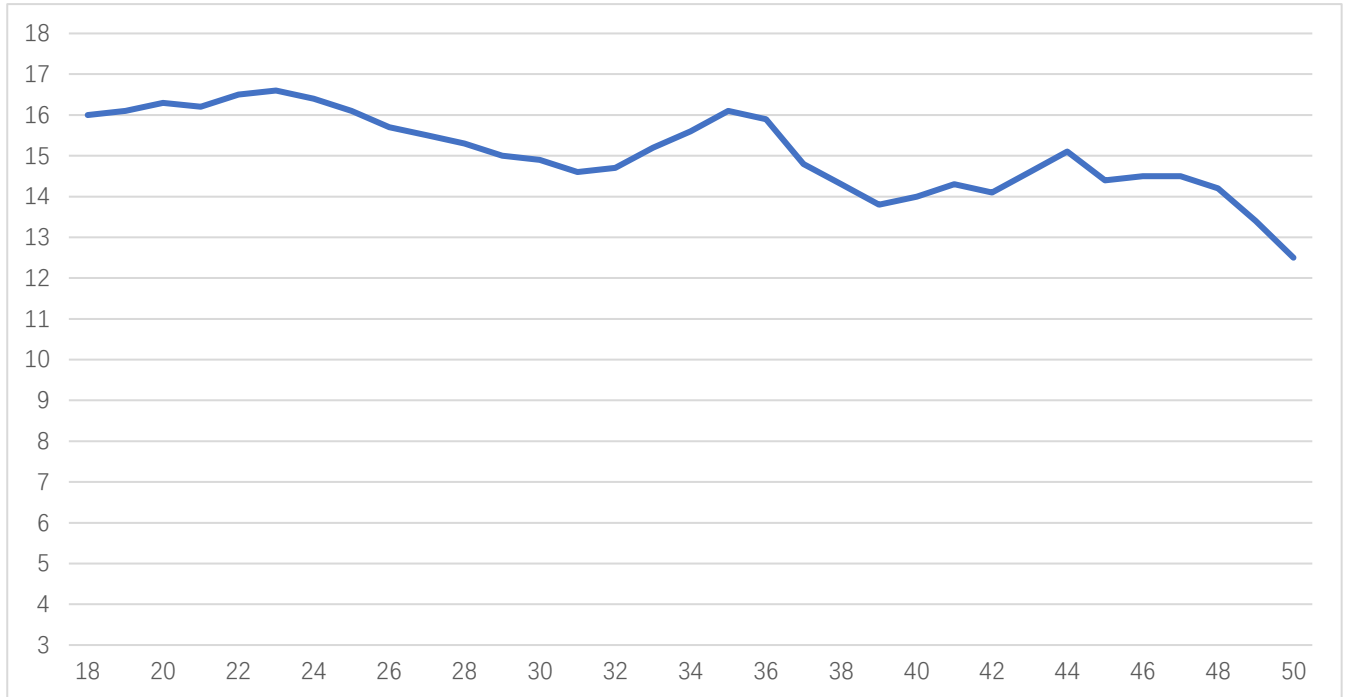

Pout vs Frequency

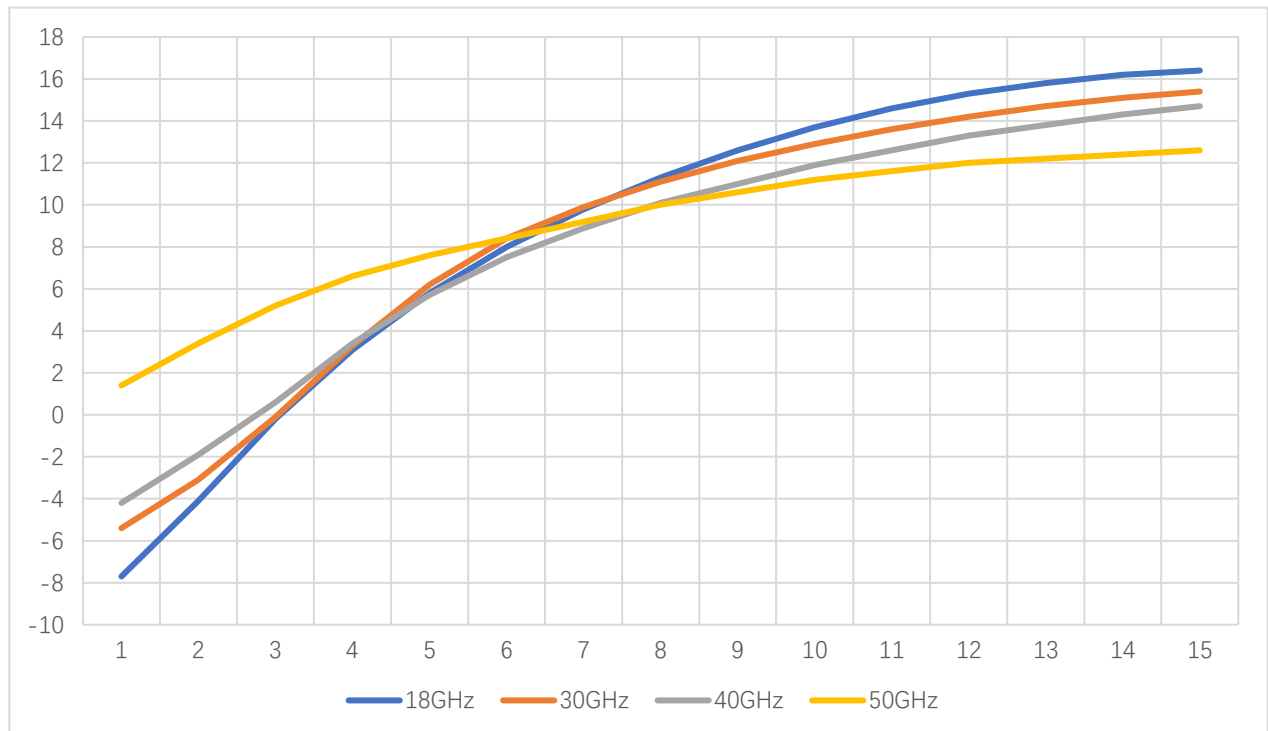

Pout vs Pin at 18/30/40/50GHz



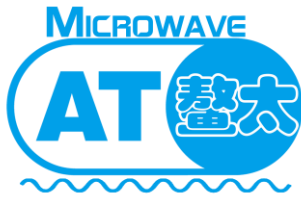

# AT-AM2-1850-15XC2

Active Multiplier x2, 18-50Hz Pout=+15dBm

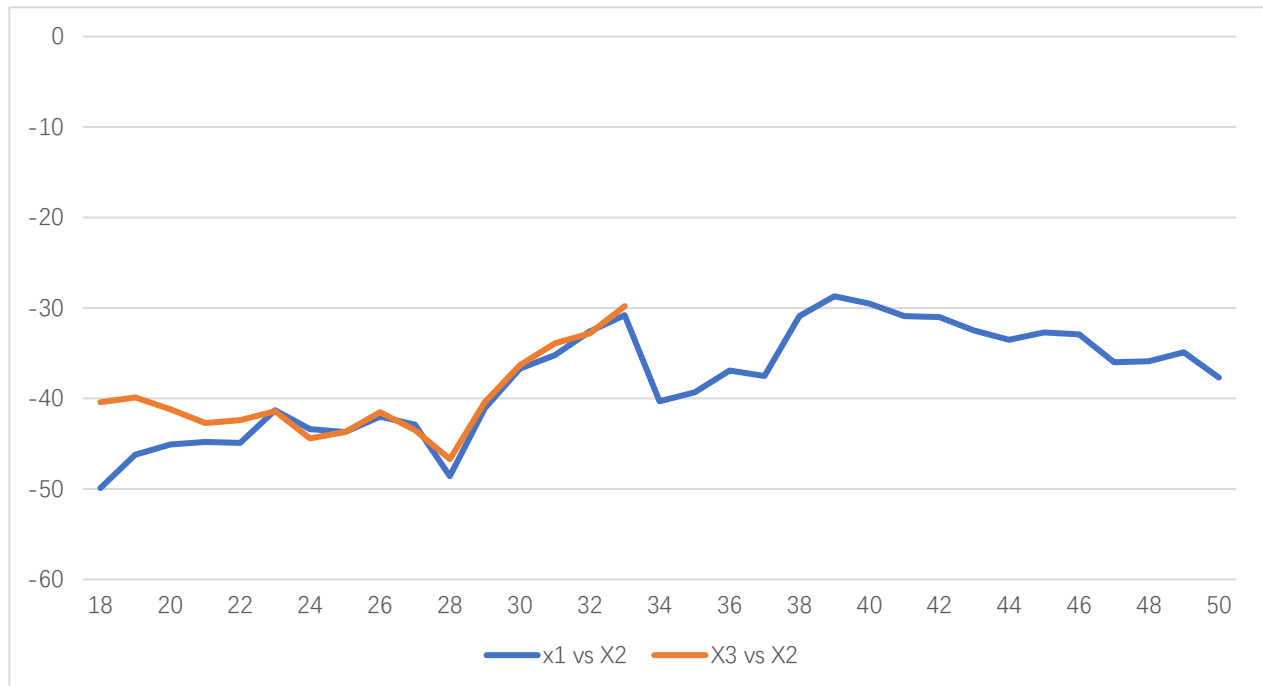

X1/X3 Harmonics



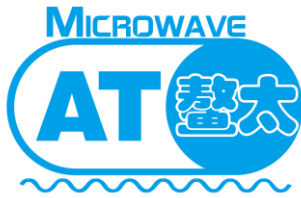

# AT-AM2-1850-15XC2

Active Multiplier x2, 18-50Hz Pout=+15dBm

## Dimension (mm)

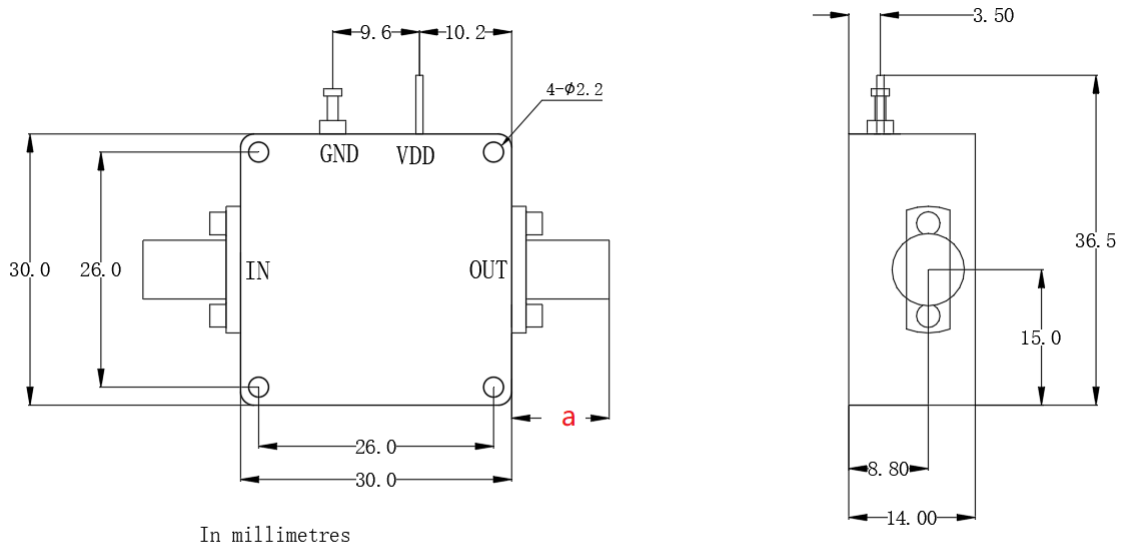

	<26.5GHz	<40GHz	<50GHz	<67GHz
Connector	SMA	2.92mm	2.4mm	1.85mm
Lenth of a	9.4mm	9.5mm	10.8mm	11.3mm

Heat Sink Required If Case Temp Higher Than 50C

